

Review

The No-Shape-Substance is the foundation all Physics laws depend on

QI Ji¹, JIANG Yinling^{1,2}

¹School of Electronic Engineering, Northeast Petroleum University, Daqing 163318, China

²College of Automation, Harbin Engineering University, Harbin 150001, China

Accepted 19 March, 2019

The author believes that No-Shape-Substance is dispersed throughout the universe, it is inseparable with the laws of physics, and the No-Shape-Substance is the foundation on which all laws of motion can be built on. From the perspective of the No-Shape-Substance, the author discuss the basic law of motion in the framework of classical physics, and reinterpret gravitational mass, inertial mass, Newton's second law, the kinetic energy equation, the momentum equation, and so on. And from a new perspective, the author explain a large number of famous experimental phenomena, such as , Eötvös' Experiment, mass addition, mass-energy equation, the prolongation of the life-span of a moving particle, Electron-positron annihilation, virtual mass, the laws of reflection and refraction, stars' running regularity, and so on.

Keywords: Gravitational Mass, inertial mass, Newton's second law, kinetic energy, mass-energy equation, momentum equation

INTRODUCTION

A mathematical frame of reference often is established to solve physical problems, which only facilitates handling them, but does not have any inevitable or direct connection with the laws of physics. However, people go so far as to establish the physical laws based on the mathematical frame of reference, which is the fundamental flaw in classical physics.

As shown in figure 1, we here consider the case that a fish swims in a river and the water flows in relation to the bank. The force acting on the fish and its law of motion are closely related to the flow of water, but not to the mathematical reference system based on the bank.

A body is analogous to the fish, while the No-Shape-Substance is analogous to the water. The motion laws of all bodies depend on the No-Shape-Substance Space where it exists but not directly on the Mathematical Space. (Qi 2015; Qi 2018; Qi 2006; Qi 2008)

In this paper, the author probes the most fundamental physical laws comprehensively from the perspective of the No-Shape-Substance.

The author will distinguish between gravitational mass and inertial mass clearly and re-define Newton's second law, as well as rederive the derivation of the kinetic equation and momentum.

In people's opinion, classical physics cannot address questions such as "mass addition," "prolonged life of moving particles," the "mass-energy equation," etc,

which are the strongest confirmations of the theory of relativity. (Einstein Collected Edition 2002; Cai 1991; Ma 1999). In this paper, the author will provide natural explanations for these phenomena.

Further, the author will offer explanations for numerous famous experimental phenomena that have had a profound influence on physics: Eotvos' experiment, the law of motion of stars, the laws of reflection and refraction, virtual mass, annihilation of positrons-electrons, and so forth.

Gravitational Mass and Inertial Mass Must be Distinguished

Before we investigate various physical laws, we must analyze the fundamental physical concepts clearly. Physics can only be solid when the physical concepts are clarified.

During the period of classical physics, people were still trying to distinguish between gravitational mass and inertial mass, which are regarded as equivalent in modern physics. Gravitational mass and inertial mass must be distinguished, as they involve the basis of all

*Corresponding author. E-mail: qiji8111@163.com, 764803310@qq.com



Figure 1. Fish swim in the water

kinematics Guo and Shen (1991).

Gravitational mass

It could be said that gravitational mass came from Newton's law of universal gravitation:

$$F = G \frac{mM}{r^2} \tag{1}$$

m and M here refer to a particle's gravitational mass.

An explicit description of gravitational mass has been provided: gravitational mass, which is still denoted by m, reflects the quantity of substances contained in a body and is a constant. Precisely speaking, it would be more appropriate to refer to it as Inherent Mass.

Therefore, think about it. Will a body with ten thousand molecules change to one with a hundred thousand or a million molecules when it is placed on the moon or sun? Apparently, the answer is no.

Think about it further; will a body with ten thousand molecules change to one with a hundred thousand or a million molecules when it is in a state of high-speed motion? Obviously, the answer still is no.

Inertial mass

Where does inertial mass come from? It comes from Newton's second law:

$$\vec{F} = m' \vec{a} \tag{2}$$

What does inertial mass mean? Inertial mass refers to the kinetic characteristic of a body, as well as the complexity of the body's acceleration under external force.

Let us think, and see whether inertial mass is constant.

Hypothetically, if a body is acted on by a force of 10N on the surface of the earth at low speed, it has an accelerated speed of 1m/s².

Then, when this body is acted on by a force of 10N on

the surface of the moon, should it have an accelerated speed of 1m/s²?

Further, when this body is acted on by a force of 10N on the sun, should it have an accelerated speed of 1m/s²?

Obviously, not always.

Hypothetically, if a body is acted on by a force of 10N on the earth's surface at low speed, it has the accelerated speed of 1m/s².

Then, when this body is acted on by a force of 10N on the earth's surface with a speed close to that of light, should it have the accelerated speed of 1m/s²?

Then, when this body is acted on by a force of 10N on the earth's surface with a speed equal to that of light, should it have an accelerated speed of 1m/s²? Obviously, not always.

Inertial mass is a completely different physical quantity from Gravitational mass. While inertial mass reflects the characteristics of a body's motion and its ability to accelerate when there is external force acting on the body, it is a variable. A body's inertial mass is associated not only with its gravitational mass, but also with the density of the No-Shape-Substance of space in which the body is. Moreover, a body's inertial mass also is related to its speed relative to the No-Shape-Substance Space in which it exists.

If we denote the inertial mass of a body by Q , we will obtain:

$$Q = m f(S) g(v) \tag{3}$$

Where $f(S)$ is the function of the density of the No-Shape-Substance in the space in which the body exists.

$g(v)$ is the function of the body's speed in the No-Shape-Substance space.

In space near the earth's surface, the density of the No-Shape-Substance, which is denoted by S_0 , is uniform. If

$$f(S_0) = 1, \text{ then}$$

$$Q = m g(v)$$

From the experiment Kaufmann and colleagues conducted on the relation between mass and speed, we can determine that:

$$g(v) = \frac{1}{\sqrt{1 - v^2/c^2}} \tag{4}$$

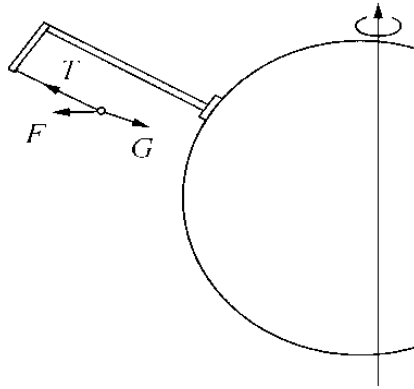

Figure 2. Eötvös' Experiment

Please note that the light speed in Equation (4) is that of the No-Shape-Substance Space in which the body exists, where

$g(v)$ equals approximately 1 when the speed is slow; therefore, in the case of low speed on the earth's surface,

$$Q = m$$

Obviously, when a body moves at a slow speed on the earth's surface, its inertial mass is numerically equivalent to its gravitational mass. However, this is just the equivalence of the numerical value; they are completely different in nature.

We will discuss primarily the functional form of $f(S)$.

Inertial mass is the result of the interplay between an object and the No-Shape-Substance space. It is desirable to increase the inertial mass when the density of a No-Shape-Substance increases according to a logical deduction. Then,

the function of $f(S)$ is:

$$f(S) = \beta S \tag{5}$$

Where β is the inertial coefficient because $f(S_0) = 1$, $\beta = 1 / S_0$.

Eötvös' experiment cannot show that gravitational mass is equal to inertial mass

In 1906, Eötvös, a Hungarian physicist, conducted a

famous experiment to verify that gravitational mass is equal to inertial mass. As Figure 2 shows, the suspended mass point eventually will reach a state of equilibrium. There are three forces acting on it:

- 1) The earth's gravitation, G, which directs the center of the earth;
- 2) The centrifugal force, F, of inertia generated by the earth's rotation;
- 3) The tension, T, acted upon by the hanging thread.

What is important is that G is proportional to the gravitational mass, while F is proportional to the inertial mass. Eötvös found no difference in the position of equilibrium with a variety of substances, such as wood, platinum, copper, asbestos, water, and copper sulfide. This negative result signifies that the gravitational mass is equal to the inertial mass (Qi 2018; Qi 2006; Qi 2008; Ni and Li 1979).

However, did Eötvös' experiment prove that gravitational mass is equal to inertial mass? No, not at all! We need to note that the experiment was conducted at the same spot on the earth's surface and the object was stationary.

From the analyses above, we have derived that the inertial mass and the gravitational mass satisfy the following relation

$$Q = m f(S) g(v)$$

Well, on the earth's surface, $f(S_0) = 1$ and $g(v) = 1$, when $v = 0$; thus, we find that:

$$Q = m$$

As discussed above, in Eötvös' experiment, the equivalence between the inertial mass of every body and its gravitational mass is inevitable. Can his experiment prove that the inertial mass and gravitational mass of the same body in different spaces are equal? No!

Can his experiment prove that the inertial mass and gravitational mass of the same body at different speeds are equal? No!

When either the density of the No-Shape-Substance in the space in which the body exists, or the speed at which the body moves differs, the gravitational mass will not equal the inertial mass.

The problem of floating wood

Let us study a simple problem of floating wood and discuss whether the mass increase in the theory of relativity is logically reasonable.

As shown in Figure 3, a wood block that has a density

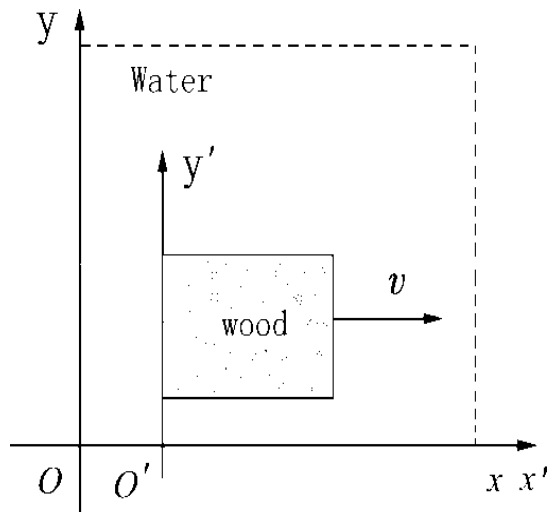

Figure 3. The problem of floating wood

of 1.0g/ml is moving at a speed of 0.8c relative to the water, the density of which is 1.0g/ml. Will the wood block float or not?

The problem is analyzed from the viewpoint of the theory of relativity as follows:

- 1) Under the condition that the water is selected as the frame of reference, the mass of the moving wood block
- 2) increases, but its length shortens. The wood block's increased density is

$$\frac{1.0}{1 - v^2/c^2} = 2.8 \text{ g / ml}$$
 and the density of water is still 1.0g/ml; therefore, the wood block will sink.
- 3) Under the condition that the wood block is selected as the frame of reference, the mass of the

moving water increases, but its length shortens. The

increased density of water is

$$\frac{1.0}{1 - v^2/c^2} = 2.8 \text{ g / ml}$$

and the density of the wood block is still 1.0g/ml; therefore, the wood block should not sink, but rather tend to float.

In summary, does the wood block float or sink? It is obvious that the predictions of the theory of relativity are contradictory.

However, if the moving body increases its inertial mass and we admit the objectivity of space, the question asked

above will have no logical contradiction.

Therefore, a large number of experiments of mass addition in modern physics proves fully the increased inertial mass of a moving body (Tan and Wang (1987).

Newton's Second Law

All of the laws of motion of a body rely on the space of total No-Shape-Substance rather than absolute space.

Previously, Newton's second law was established directly according to the empty reference system of mathematics, which is incorrect. We have to re-describe Newton's second law strictly.

When a resultant force of zero acts upon a body, its acceleration relative to the total No-Shape-Substance space in which it exists is zero.

When a certain external force that is not zero acts upon a body, the product of its acceleration relative to the total No-Shape-Substance space in which it exists and its inertial mass are equal to the resultant force that acts upon the body.

$$\vec{F} = Q \vec{a} \tag{6}$$

The above is a more exact presentation of Newton's second law.

Here we need to explain that Newton described his second law in the book, *The Mathematical Principles of Natural Philosophy* as follows: the change in a body's momentum is proportional to the motive force acting on it.

$$\vec{F} = \frac{d\vec{P}}{dt} = \frac{d(m\vec{v})}{dt}$$

This is the initial expression of Newton's second law. Notice that the inertial mass is considered under the condition that it does not change with speed. When the inertial mass varies with speed, the momentum will not be in the form of

$$\vec{P} = m\vec{v}$$

You will find the form of momentum in the following. The reason to re-describe inertial mass and Newton's second law or even redefine it is to make physical concepts more explicit and distinct.

Newton's bucket experiment

Newton once made an argument for the existence of absolute space as follows:

We spin a bucket filled with water. When the bucket is spinning and the water is still, the surface of the water remains on the same plane. However, when the water is

spinning along with the bucket, a concave surface emerges. This experiment indicates that when the water is still, its surface is flat, regardless of whether its motion is relative to the bucket; however, when the water is spinning, its surface is concave whether or not it is resting relative to the bucket.

If the frame of reference is the inner wall of the bucket, the physical law conflicts with the facts:

1. Initially, the bucket is spinning and the water is still, as it is spinning relative to the frame of reference set on the bucket. Yet, the surface of the water should be concave because of the centrifugal force imposed on it. However, instead, the surface of the water is completely flat.

2. When the water is spinning together with the bucket, relative to the bucket's frame of reference, the water has no motion; therefore, its surface should be flat because no centrifugal force should be imposed on it. However, in fact, the surface of the water is exactly concave.

Faced with this contradiction, Newton said that: this exactly explains the existence of the "absolute space." According to the concave or flat surface of the water, it can be determined that water is relative to the "absolute space" is still or spinning (Qi 2018; Qi 2006; Qi 2008; Ni and Li, 1979).

If the law of motion of an object does not depend on the "absolute space," but on the total No-Shape-Substance space in which it is located, how are we supposed to interpret the bucket experiment?

In the space where water is located, compared with the density of the earth's the No-Shape-Substance, the density of the No-Shape-Substance in the bucket of water is very small, and thus, the bucket's motion has only a slight influence on the total No-Shape-Substance. The total No-Shape-Substance could be represented by the earth's the No-Shape-Substance.

When the water is still relative to the earth as well as the total No-Shape-Substance space, the surface of the water is flat, as no centrifugal force is imposed on it.

When the water is spinning relative to the earth as well as the total No-Shape-Substance space, the water surface is concave as centrifugal force is imposed on it.

Now, from the perspective of the No-Shape-Substance, we can understand Newton's bucket experiment easily.

Relativity denies the existence of "absolute space" and believes that all motions are relative. Relativity cannot face such simple problems as Newton's bucket experiment.

Re-deduction of Kinetic Energy Equation

A body's kinetic energy is the energy it possesses when it moves with reference to the total No-Shape-Substance space in which it exists.

We then deduce the kinetic energy of a body, E . We

assume that initially, the particle is immobile relative to the total No-Shape-Substance space $v = 0$, which indicates that its original kinetic energy is zero. Then, we exert an external force on the body to make it move in a straight line. When the speed of the particle increases to v , its kinetic energy equals the work done by the external force acting upon it. This can be expressed as:

$$E = \int F dx$$

Substituting Qa for F in the equation above, we obtain:

$$E = \int Q a dx$$

Again, replacing $\frac{dv}{dt}$ for a and then $\frac{dx}{dt}$ for v in the equation, it follows that:

$$E = \int_0^v Q v dv \tag{7}$$

In the No-Shape-Substance space near the earth's surface, when the body moves at a slow speed, $Q = m$. Then, the body's kinetic energy is:

$$E = m \int_0^v v dv = \frac{1}{2} m v^2 \tag{8}$$

This is the kinetic energy equation with which we are familiar.

In general, $Q = m f(S) g(v)$. Therefore, the kinetic energy is as follows:

$$E = \int_0^v Q v dv = m f(S) \int_0^v g(v) v dv = m f(S) \int_0^v \frac{v}{\sqrt{1 - v^2/c^2}} dv$$

As a result:

$$E = m f(S) c^2 \left(1 - \sqrt{1 - \frac{v^2}{c^2}} \right) \tag{9}$$

This is the kinetic energy equation for the general condition.

Here, let us look at the following particular case. On the earth's surface, what will the kinetic energy be if the

Table 1. Experimental Data and Various Theoretical Values

Energy Temperature	1.6MeV	6MeV	8MeV	10MeV	12MeV	15MeV
Relativistic value	0.67 °C	2.52 °C	3.36 °C	4.20 °C	5.03 °C	6.29 °C
Experimental value	0.26 °C	0.29 °C	0.32 °C	0.32 °C	0.32 °C	0.32 °C
New physical value	0.30 °C	0.30 °C	0.30 °C	0.30 °C	0.30 °C	0.30 °C

speed of a moving body approaches the speed of light?
Its kinetic energy is:

$$E = m f(S_0)c^2 \left(1 - \sqrt{1 - \frac{c^2}{c^2}} \right) = m c^2 \tag{10}$$

Unexpectedly, this is the mass-energy equation with which we are familiar.

Mass-energy equation

Mass is mass and energy is energy. They are two different kinds of things in essence. Mass and energy cannot be transformed into each other. Mass is conserved, so is energy.

When nuclear fission occurs, an atomic nucleus will release a great number of particles with high energy and with a speed that approaches the speed of light. The mass removed by these particles is the mass the atomic nucleus loses. Further, the kinetic energy acquired by these particles is converted from the inner energy of the atomic nucleus. Both mass and energy are conserved.

From Equation (10) above, we can derive the following equation between the mass and energy removed by these particles:

$$E = \Delta m c^2 \tag{11}$$

Now it is simple for us to understand the mass-energy equation. Photons are the No-Shape-Substance in nature. Thus, a photon's mass is not zero. It is

$$m_0 = \frac{h\nu}{c^2}$$

It is regarded that the mass-energy equation is a great symbol of the Theory of Relativity. The following is a brief exploration.

The theory of relativity proposes that mass and energy can convert to each other, and the energy that is released at the time of nuclear fusion derives from the conversion

of mass.

It is known well that the binding energy increases greatly during nuclear fusion, while the potential energy decreases greatly. If all of the energy released is converted from the mass, then where is the potential energy that decreases?

Calorimetric measurements of energy

As Table 1 shows, Ji Hao, who works at the Shanghai Oriental Institute of Electromagnetic Waves in china, bombarded a lead (Pb) target with high-speed electrons obtained from a beam current of 1.26A with energies of 1.6, 6, 8, 10, 12, and 15MeV, respectively, based on Bettozzi's 1964 experiment, and measured the electron energy directly with calorimetric measurements. The experimental values obtained differed greatly from those described in the theory of relativity (Qi 2018; Qi 2006; Qi 2008, Ji 2009, Zhang 1979).

According to the energy equation in the theory of relativity, it is believed that the total electron energy is:

$$E = \frac{m_e}{\sqrt{1 - v^2/c^2}} c^2$$

When the electron's speed approaches light speed, its energy tends to infinity. After being accelerated by voltages of 1.6, 6, 8, 10, 12, and 15MV, the electron will acquire those energies, and will increase the Pb target's temperature by 0.6, 2.52, 3.36, 4.20, 5.03, and 6.29 °C, respectively.

In his experiment, Ji Hao directly measured the energy of the accelerating electrons, the results of which demonstrated that the energy will tend to a steady state value when the electron approaches light speed. This is totally different from the results predicted by the theory of relativity.

However, the results of Ji Hao's experiment are in complete accord with our deduction.

Constant photon energy

The mass of a photon is not zero. From Equation (10), it

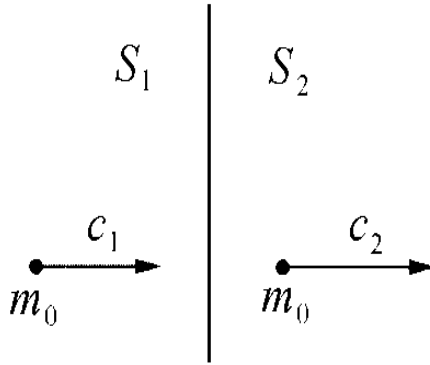

Figure 4. Photon

is known that, on the earth's surface, a photon's energy is:

$$E = m_0 c^2$$

Further, a photon's energy is $E = h\nu$; therefore, its mass is:

$$m_0 = \frac{h\nu}{c^2}$$

Here is a brief introduction. According to the theory of relativity, the resting mass of a photon is zero. Then, according to the mass-speed relation, mass-energy relation, and the kinetic energy equation in the theory, a photon's energy and momentum in the medium must be zero, which obviously contradicts objective physical fact!

We say that a photon's mass is not zero. Let us examine its kinetic energy in the No-Shape-Substance spaces of various densities. The speeds of photons differ in the No-Shape-Substance spaces of various densities. Is their energy the same?

As shown in Figure 4, if the mass of some photon is m_0 , let us calculate its energy when moving in the No-Shape-Substance spaces of various densities. We know from the kinetic energy Equation (9) that the energy of a photon (kinetic energy) is:

$$E = m_0 f(S)c^2 \tag{12}$$

In the No-Shape-Substance space with a density of S_1 , the energy of the photon is:

$$E_1 = m_0 f(S_1)c_1^2 = m_0 \beta S_1 \left(\sqrt{\frac{W}{S_1}} \right)^2 = m_0 \beta W$$

In the No-Shape-Substance space with a density of S_2 , the photon's energy is:

$$E_2 = m_0 f(S_2)c_2^2 = m_0 \beta S_2 \left(\sqrt{\frac{W}{S_2}} \right)^2 = m_0 \beta W$$

When the photon is propagating in the No-Shape-Substance spaces of various densities, its energy is constant, although its speed differs. Perhaps this is the harmonious beauty of light!

The Objectivity of Time

What is time? It is simply an immensely long river flowing from antiquity into the future.

The Analects of Confucius say: Time runs away like a river, without stopping day or night.

Time is just like a rushing river ceaselessly on the move. It is like the water of the Yellow River that comes from the sky and flows into the sea without ever returning.

However, how can the Yellow River, whose flow is always in a broken state, compare with time?

Time is like the sun and stars in the sky, rising in the east and setting in the west day after day. Time is like the immense Milky Way, going round and round ceaselessly forever.

However, the Milky Way cannot compare with vast time either.

The gear wheel of time juggles the whole universe and drives all galaxies to rotate toward the everlasting future (Qi 2018; Qi 2006; Qi 2008; Lei 2001).

And Newton always said, "The absolute, real or mathematical time, itself and to the extent of its nature, always lapses uniformly, having nothing to do with any outside body."

Time reflects all of existence and the changes in the entire universe; thus, time is our measure of existence and the changing processes of the universe.

Time is the most essential objective fact in the universe, and the movements of a trivial object, a star, or even a galaxy, absolutely cannot change the objective state of time.

We have been measuring time using a relatively stable law of the operation of the universe as the reference. For example, it takes 1 year for the earth to revolve once around the sun and 1 day for the earth to rotate once around. One day is divided equally into 24 hours, one hour is divided equally into 60 minutes, and one minute is divided equally into 60 seconds.

This is the concept of time in classical physics and also is people's inherent concept of time.

The prolongation of the life-span of a moving particle

There are a number of high-speed μ^- mesons within the cosmic rays from outer space. In an experiment

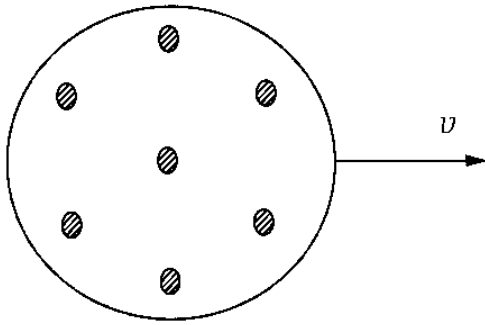

Figure 5. μ^- meson

conducted in 1963 on the top of a 1910-meter-high mountain, they measured the number of μ^- mesons the downward vertical speeds of which varied from 0.9950c to 0.9954c. They found that there were 563 ± 10 μ^- mesons per hour on average. Further, they measured the number of μ^- mesons with the same range of speed at an altitude of 3 meters above sea level. The average result found was 408 ± 9 . The time it takes for a μ^- meson to fall from the top of a mountain to sea level should be:

$$t = \frac{1910 - 3}{0.9952 \times 3 \times 10^8} = 6.4 \times 10^{-6} \text{ (s)}$$

This is four times as long as the half-life ($T_{1/2}$) of an immobile μ^- meson. If the half-life of a μ^- meson moving at a high speed is equal to that of an immobile one, it is expected that the number of μ^- mesons near sea level should be less than

$$\frac{563}{2^4} \approx 35$$

after traveling a distance of 1907 meters. However, the practical number acquired from the experiment was 408.

This indicates clearly that the half-life of a moving μ^- meson is prolonged, in that its process of decay slows (Qi 2018; Qi 2006; Qi 2008; Ni and Li 1979).

How can we explain the problem in this experiment? It is simple. The high-speed motion of a μ^- meson in the No-Shape-Substance space extends its life-span. Similarly,

as Figure 5 shows, a μ^- meson also is composed of smaller mass units and the mutual collisions among them cause the μ^- meson to decay. When a μ^- meson moves at a high speed in the No-Shape-Substance near the earth's surface, the inertial mass of every mass unit in the μ^- meson increases, and at the same time, the relative speed of every mass unit decreases because of the unchanged vibration momentum. As a result, the time interval of collisions between these mass units of the μ^- meson increases, and thus, the μ^- meson's lifespan is extended.

We will estimate the lifespan of a μ^- meson by the following method. When a μ^- meson moves at a high speed in the No-Shape-Substance space, the inertial mass of each of its mass units increases by $g(v)$ times as much as the inertial mass of each mass unit of an immobile μ^- meson. Because the vibration momentum of each mass unit does not change, the relative speed of each mass unit decreases by $1/g(v)$ times as little as the relative speed of each mass unit of an immobile μ^- meson. Therefore, the time interval of collisions among the mass units of a μ^- meson increases by $g(v)$ times the original value, and accordingly, the lifespan of the μ^- meson extends by $g(v)$ times its original value. We can express this by the following equation:

$$\tau = g(v)\tau_0 = \frac{\tau_0}{\sqrt{1 - v^2/c^2}}$$

Where τ is the lifespan of a moving μ^- meson and τ_0 is that of an immobile μ^- meson.

When the v is substituted with the experimental data, we obtain:

$$\tau = \frac{\tau_0}{\sqrt{1 - (0.9952)^2}} = 10.2\tau_0$$

However, the lifespan of a μ^- meson acquired from the experiment above is $\tau = 9.1\tau_0$.

What we can see from the above is that, although the



Figure 6. Conservation of momentum

theoretical value approaches the experimental value to some extent, there is a larger error between them. Why is the theoretical value larger than the experimental value? Let us look at the following analysis. Because the μ^- mesons were sent from a high altitude, their collisions with atmospheric molecules will cause the number of μ^- mesons measured on the earth's surface to be smaller than the number flying in the vacuum.

Therefore, the practical lifespan of a μ^- meson based on the measurement is smaller than is the theoretical value.

In 1966, scientists made the μ^- mesons move at a high speed on the earth's surface and circle in a round orbit, and ensured that their speed satisfied the following equation:

$$\frac{1}{\sqrt{1 - v^2/c^2}} = 12$$

As a result, they measured the lifespan of the μ^- mesons as:

$$\tau' = (26.15 \pm 0.003) \times 10^{-6} \text{ s}$$

Now, we calculate the theoretical lifespan of the μ^- meson again. The result is:

$$\tau = \frac{\tau_0}{\sqrt{1 - v^2/c^2}} = 26.5 \times 10^{-6} \text{ s}$$

We can see from this that the theoretical value and the experimental value agree well.

An acceleration process has been included in many experiments that validate time dilation. Further, the range of the acceleration is very wide. For example, in an experiment in which a clock sailed around the earth, the centripetal acceleration that acted on the atomic clock was 10-3g, where g is the acceleration of gravity on the earth's surface; in the rotating-disk experiment, the centripetal acceleration of the light source extends to 105g; in an experiment on the temperature dependence of the Mossbauer effect, the vibrating acceleration of the atomic nucleus in the crystal lattice and the centripetal acceleration of the meson moving in

a circle were both greater than 1016g. Although the range of the acceleration is so large, almost all of the experimental results are consistent with the basic formula,

$$\tau = \frac{\tau_0}{\sqrt{1 - v^2/c^2}}$$

This fact indicates that the acceleration did not contribute to time dilation in the experiment. Even if we admit the existence of the effect of time dilation, we can say only that it is caused by speed rather than acceleration (Qi 2018; Qi 2006; Qi 2008; Huang 2001). We can understand these experimental results easily. Because speed affects inertial mass, acceleration will neither affect inertial mass, nor particle life.

Time, which is objective and absolute, is the foundation on which we learn about nature.

The extension of the lifespan of a moving particle does not prove time dilation, but shows that the self-reaction of the particle slows after it moves at a high speed relative to the corresponding the No-Shape-Substance space in which it exists.

Momentum

Does the momentum of a body satisfy the following relation precisely?

$$\vec{P} = m\vec{v} \tag{13}$$

No, the expression above of a body's momentum is not exact. Such an expression does not reveal the essence of the momentum. Specifically, what the momentum theorem reflects is the essential source of the momentum, in that the impulse acting on a body equals the increment in the body's momentum. This can be expressed as:

$$d\vec{P} = \vec{F} dt$$

As Figure 6 shows, the momentum of a system free of any external force is conservative, because the internal forces of the system are actions and reactions that are equal in magnitude and opposite in direction, and the duration of time of the pairs of forces always is correspondingly equal. Therefore, the resultant impulse acting on this system is zero, which means the momentum of this system is conservative.

The impulse acting upon a body equals the increment in its momentum. This expression can be written as:

$$\Delta\vec{P} = \int \vec{F} dt$$

If we set a body's initial speed to zero and allow it to move in a straight line, we will deduce the relation for momentum as follows:

$$dP = F dt$$

By substituting Qa for F , and then substituting $\frac{dv}{dt}$ for a in the equation above, we obtain:

$$dP = Q dv$$

When the speed of a body is zero ($v = 0$), its momentum also is zero ($P = 0$), so a body's momentum at any time is:

$$P = \int_0^v Q dv \tag{14}$$

When a body moves slowly on the earth's surface, its value of Q , which equals m , is a constant. Thus:

$$P = m \int_0^v dv = mv \tag{15}$$

This is the formula for momentum with which we are familiar. The direction of speed is the direction of the momentum. Expressing it with vectors, we obtain:

$$\vec{P} = m\vec{v}$$

In the general case, $Q = m f(S) g(v)$.

$$P = \int_0^v m f(S) g(v) dv = mf(S) \int_0^v \frac{1}{\sqrt{1-v^2/c^2}} dv$$

Solving for P in the equation above, we obtain:

$$P = mcf(S) \arcsin \frac{v}{c} \tag{16}$$

The direction of speed is the direction of the momentum. Expressing it with vectors, we obtain:

$$\vec{P} = mcf(S) \arcsin \frac{v}{c} \vec{e}_v$$

where \vec{e}_v is the unit vector in the direction of speed. Now let us look at a particular case. On the earth's

surface, when a body v equals the speed of light, c , what is the magnitude of its momentum?

We know that $f(S_0) = 1$ on the earth's surface, but when $v = c$

$$\arcsin \frac{c}{c} = \frac{\pi}{2}$$

Therefore:

$$P = mc \frac{\pi}{2} \tag{17}$$

Laws of Reflection and Refraction

Huygens explained the reflection and refraction laws of light well from the perspective of light's wave characteristics. We acknowledge the wave character of light, and we surely acknowledge Huygens' explanation.

The law of the reflection of light also can be obtained properly by Newton's view of the corpuscular property of light; however, Newton obtained the opposite result when he analyzed the law of refraction.

Let us look at Newton's analysis. As shown in Figure 7, as we all know, there is no energy lost when there is a perfect elastic collision with a ball. The outside force acts on the ball in the normal direction, so the tangent component of the ball's momentum is invariable.

Incident light and reflected light propagate in medium 1

at a speed of c_1 and momentum of $P_1 = mc_1$. As the momentum of the small ball is the same in the tangential direction, then:

$$mc_1 \sin \alpha = mc_1 \sin \beta$$

$$\therefore \alpha = \beta$$

Incident light propagates in medium 1 at a speed of c_1

and momentum of $P_1 = mc_1$, while refracted light propagates in medium 2 at a speed of c_2 and momentum

of $P_2 = mc_2$. Because the momentum of the small ball is the same in the tangential direction, then:

$$mc_1 \sin \alpha = mc_2 \sin \gamma$$

$$\frac{\sin \alpha}{\sin \gamma} = \frac{c_2}{c_1}$$

The result Newton obtained is precisely opposite to the

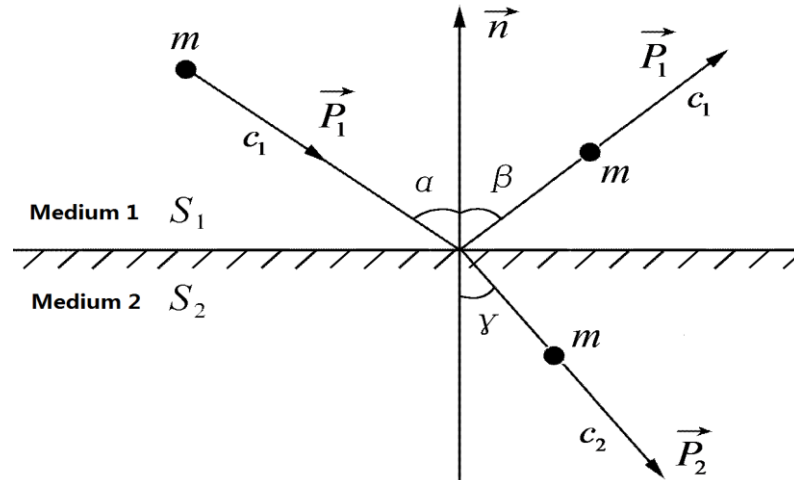

Figure 7. Reflection and refraction of a photon at the interface

law of refraction. As the speed of light could not be measured at that time, Newton believed that the light speed in a medium was greater than that in a vacuum.

Law of reflection

We re-deduced the momentum equation previously. Let us see if the laws of reflection and refraction can be obtained from a photon's perspective.

As Figure 7 shows, when a photon is reflected or refracted at the interface, the No-Shape-Substance in the tangential direction retains the same density. The photon is not acted upon by any force in the tangential direction, and its momentum component remains the same.

As we know from Equation 16, a photon's momentum in Medium 1 is:

$$P_1 = m c_1 f(S_1) \frac{\pi}{2}$$

Just like incident light, reflected light causes the photon to move in Medium 1 with the same momentum and momentum component in the tangential direction, then:

$$P_1 \sin \alpha = P_1 \sin \beta$$

$$\therefore \alpha = \beta \tag{18}$$

Law of refraction

Now let us analyze the law of refraction from the perspective of a photon. As shown in Figure 7, when a photon is refracted on the interface of a medium, the No-Shape-Substance in the tangential direction retains the same density. The photon is not acted upon by any force in the tangential direction, and its component of

momentum remains the same. The momentum of a photon in Medium 1 is:

$$P_1 = m c_1 f(S_1) \frac{\pi}{2}$$

while its momentum in Medium 2 is:

$$P_2 = m c_2 f(S_2) \frac{\pi}{2}$$

The photon's component of momentum remains the same in the tangential direction.

$$P_1 \sin \alpha = P_2 \sin \gamma$$

$$m c_1 f(S_1) \frac{\pi}{2} \sin \alpha = m c_2 f(S_2) \frac{\pi}{2} \sin \gamma$$

Since $f(S) = \beta S$ and $c = \sqrt{\frac{W}{S}}$,

we get

$$\beta S_1 \sqrt{\frac{W}{S_1}} \sin \alpha = \beta S_2 \sqrt{\frac{W}{S_2}} \sin \gamma$$

Thus,

$$\frac{\sin \alpha}{\sin \gamma} = \sqrt{\frac{S_2}{S_1}}$$

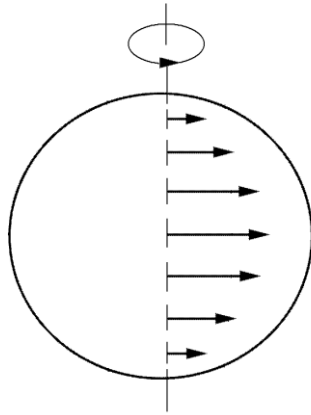

Figure 8. Rotation of the Dark matter along with stars

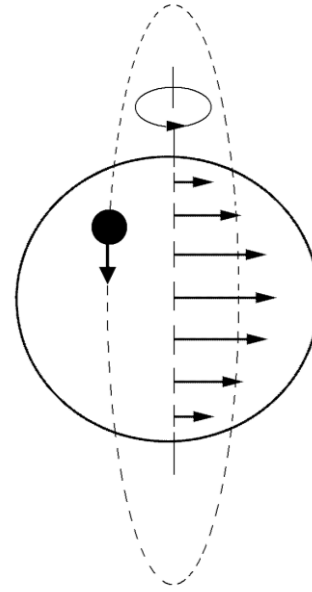

Figure 9. Original orbit of satellite

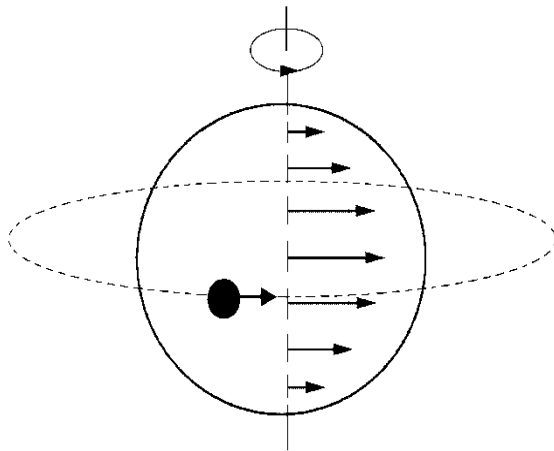

Figure 10. Final steady orbit of satellite

Because $c_1 = \sqrt{\frac{W}{S_1}}$, $c_2 = \sqrt{\frac{W}{S_2}}$, so $\frac{c_1}{c_2} = \sqrt{\frac{S_2}{S_1}}$,

we obtain:

$$\frac{\sin \alpha}{\sin \gamma} = \frac{c_1}{c_2} \tag{19}$$

This is the law of refraction of light at the interface.

Motion Law of Stars

We say that when a star is rotating, some of the No-Shape-Substance nearby will be rotating along with it. If so, what influence will it have on the satellites revolving around the stars?

As Figure 8 shows, when the star is rotating, some of the No-Shape-Substance nearby will be rotating with it. From the frame of reference of cosmic space, we can see that the No-Shape-Substance is rotating and is driven in the same direction by the star.

As Figure 9 shows, if the orbital plane of the satellite is perpendicular to the star's plane of rotation, the No-Shape-Substance will divert the satellite passing at the top of the star to the right, and will divert the satellite passing at the bottom of the star to the left. The orbital plane of the satellite will divert counterclockwise gradually and finally become parallel to the plane of rotation of the star and they will pass round in the same direction, thereby achieving a stable state.

Figure 10 shows that this is the steadiest rotational orbit of a satellite around the star. Regardless of its original state, it will be driven into this steady state.

The cosmos has formed for hundreds of millions of years, and even if a star's rotation drives distant the No-Shape-Substance only slightly, it is sufficient to cause the star's satellites to achieve the steady state described above. Do some of the actual movements of the stars correspond to this law? Let us review the law of motion with our most familiar stars.

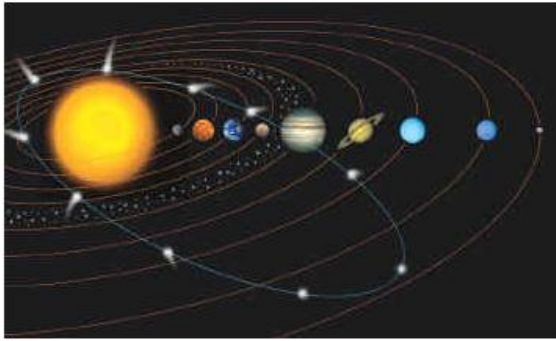

Figure 11. Solar system



Figure 14. Lateral view of the NGC891

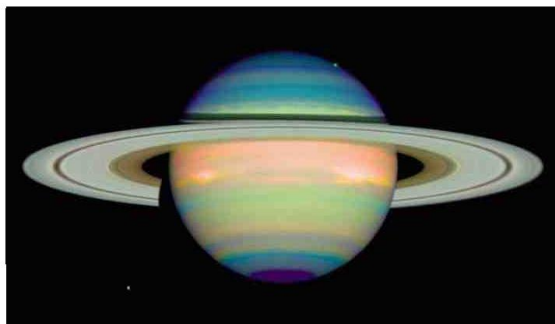

Figure 12. Saturn



Figure 15. Spiral galaxy m83

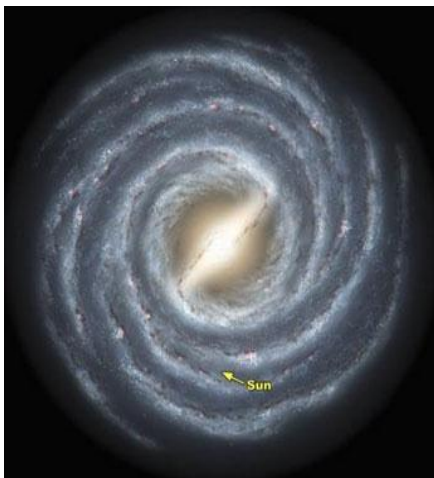

Figure 13. Galaxy

1. The direction in which the moon revolves around the earth is the same as the direction of the earth's rotation—the moon rises later than on the previous day. The moon rotates around the earth from west to east, which is the same direction as that of the earth.

2. As shown in Figure 11, all of the nine planets are

arranged in elliptical orbits and revolve around the sun in nearly the same plane and same direction, such that the orbital motion of the co-planarity and directionality. A slight offset is found only for Mercury and Pluto. The direction in which the sun rotates is the same as that of the planets.

3. As Figure 12 shows, Saturn has a very charming and splendid discoid ring that is unbelievably thin, as its diameter is hundreds of thousands of kilometers while it is only a few meters thick. Saturn's ring can be compared to a record. It is composed of billions of ice cubes arranged in the planet's gravitational orbit, each piece of which is a small satellite.

4. Figure 13 shows the general view of our galaxy.

5. Figure 14 Lateral view of the NGC891 Galaxy taken in 2005 with a large binocular telescope. The lateral view of our galaxy is also the same.

6. Figure 15 Enormous, beautiful and bright spiral galaxy m83, similar to our Galaxy's state and size.

7. Figure 16 Enormous, Extragalactic galaxy closest to our galaxy

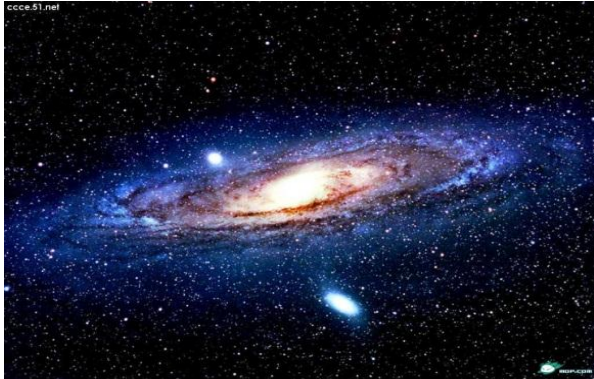

Figure 16. Extragalactic galaxy closest to our galaxy

Is this coincidence, my friend? The laws of operation of these celestial bodies fully conform to our judgment. These indisputable facts demonstrate further the existence of a substance in another state in space, which is the foundation of the law of motion of a body.

CONCLUSIONS

Because of the limitations of history, people did not realize that there is a substance in another state that exists in space. Therefore, the physical laws were established with reference to mathematical space, which was the fundamental error of classical physics.

When the author created New Physics in 1991, he believed that there must be another state of matter in nature and called it "No-Shape-Substance". Now, people have confirmed that there is a large amount of Dark matter in nature. In fact, this just confirms the author's prediction.

The author believes that No-Shape-Substance is dispersed throughout the universe, it be inseparable with the laws of physics, the No-Shape-Substance is the foundation on which all laws of motion can be built.

From the perspective of the No-Shape-Substance, the author discuss the basic law of motion in the framework of classical physics, and reinterpret gravitational mass, inertial mass, Newton's second law, the kinetic energy equation, the momentum equation, and so on.

And from a new perspective, the author explain a large number of famous experimental phenomena, such as , Eötvös' Experiment, mass addition, mass-energy equation , the prolongation of the life-span of a moving particle, Electron-positron annihilation, virtual mass, the laws of reflection and refraction, stars' running regularity , and so on.

To study physical laws from an objective, material and conform to logic, this is the inevitable direction of the development of physics.

REFERENCE

- Qi J (2015). A No-Shape-Substance is the propagating medium of light. *Int. J. Phy. Sci.*, 3(1):6-16,
- Qi J (2018). *New Physics [M]*. AMERICAN ACADEMIC PRESS.
- Qi J (2006). *New Physics[M]*. Harbin: Publishing House of Northeast Forestry University.
- Qi J (2008). The review on the basic physical laws—the New Physics[J], *Phys. Essays* 21, 163.
- Einstein Collected Edition, Hunan Science and Technology Publishing Company, 2002.
- Cai B (1991). "Special Relativity Theory", Higher Education Press.
- Ma W (1999). *Physics*, Higher Education Press.
- Ni G, Li H (1979). "Modern Physics", Shanghai Science and Technology Publishing Company.
- Tan Sh, Wang H (1987). "Important Experiments on Physics", Science and Technology Literature Company.
- Guo Y, Shen H (1991). "Famous Classical Physics Experiments", Beijing Science and Technology Publishing Company.
- Zhang Y (1979). *The Experimental Basic of Theory of Special Relativity*, Science Press.
- Ji H (2009). Experiment of Measuring Electronic Energy with Calorimetry Method, *Chinese scientific and technological achievements.*, 1, P34-35
- Lei Y (2001). *The Chaos of Time-Space*, Sichuan Science and Technology Publishing Company.
- Huang D (2001). *On the Nature of Physical Phenomena*, Shanxi Science and Technology Publishing Company.